

VCS/VCFS

Prevent future leaks and blowouts



For Zero Fugitive Emissions & Extreme Critical Sealing Applications

The VCS/VCFS systems use proprietary materials to address the regulations associated with fugitive emissions requirements that are closely monitored and highly sensitive to regulatory agencies today.

Patent # 2271866

VCS/VCFS Sealing & Isolation

FEATURES

- » Extreme, high-reliability sealing and electrical isolation solution for critical service applications
- » Seals and isolates all pressure ratings through ANSI 2500 class and API 10,000 psi service
- » Withstands severe service conditions including vibration, temperature and pressure fluctuations
- » Designed to withstand corrosive environments, including high concentrations of CO₂, H₂S, produced water and aggressive inhibitors
- » Good electrical isolation properties for cathodic protection
- » Pressure-activated seals provide high confidence sealing, eliminates costly leaks and provides a solution for fugitive emissions
- » Gasket is sized to the bore to protect flange faces from media-induced corrosion and flow-induced erosion
- » Prevents turbulent flow at flanged connections
- » Mitigates galvanic corrosion in dissimilar metal flanges
- » High-strength laminate material resists failure due to excessive compression
- » Available to match any flange specification (ANSI, ASME, API, MSS, BS, DIN, AS, others)
- » Can mate mismatched RTJ with raised-face flanges
- » Easy installation, make up and removal
- » Sealing system is not sensitive to low bolt loads - providing reliable sealing through a range of bolt stress
- » Gasket is self-aligning and centering - quick to install and no special tools are required
- » Maintenance-free corrosion-resistant design is resistant to deforming under load
- » Works in Ring Joint Flanges, reducing fluid entrapment, flow induced erosion and media induced corrosion between flanges
- » Reusable by simply replacing sealing ring

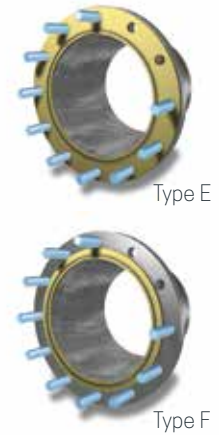

Sealing element may be positioned anywhere between the I.D. of the gasket and I.D. of the bolt circle depending on flange design.

NOTE:
Can be custom made to order

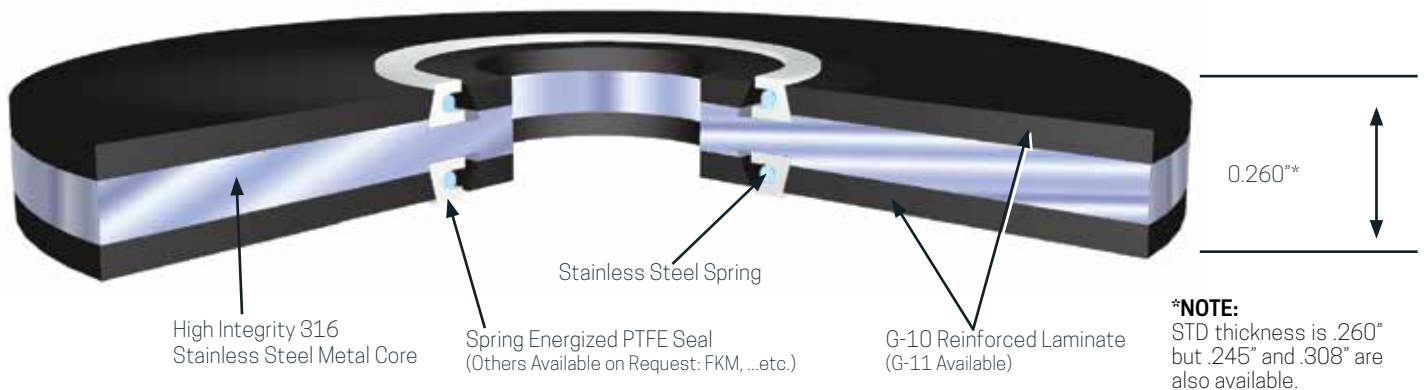

APPLICATIONS

- » H₂S Service
- » High pressure flanges
- » Critical service applications
- » High pH Service
- » Locations where one prefers an integral seal element
- » A more convenient spiral-wound type gasket replacement



Before Tightening

The flange faces come into contact with the sealing elements, which extend slightly above the surface of the retainer. As the flange is tightened the sealing elements are compressed into the machine groove, developing an initial high unit pressure against the flange faces.

NOTE:
Can work for ring joint flanges reducing fluid entrapment.



After Tightening

The flange faces come into firm contact with the retainer, thus compacting the sealing elements within grooves. At the same time, the unique VCS spring energized seal provides elastic memory for a polymer not normally associated with this characteristic - resulting in a simple flat gasket with extremely high loading and self energizing characteristics without adverse cold flow problems.

VCS/VCFS Sealing & Isolation

VCFS FIRESAFE

- » Based upon proven GPT VCS platform
- » Provides complete flange electrical isolation
- » Tandem seal technology
- » PTFE sealing system has 30+ years successful track record
- » E-Ring sealing systems is dual purpose fire safe and backup
- » Passed API 6FB, 3rd Edition Fire Test
- » Use in conjunction with cathodic protection systems
- » Mitigates potential flange rotation
- » Provides a tighter seal under low bolt loads

INTRODUCTION

The creation of the VCFS was driven by the demands of our customers who needed to electrically isolate their flanges but worried about the performance of non-metallic components in the event of a fire. This was especially a concern in the offshore market where the consequences of a fire on platforms are very hazardous and costly.

Additionally, the needs of users in piping and LNG applications, where the risk of a fire would greatly threaten life and property, drove the need for an electrical isolation seal that is fire safe per API 6FB.

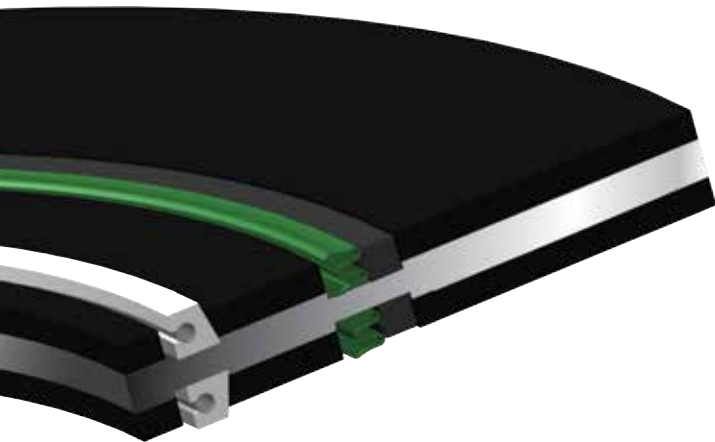

Before Fire

DEVELOPMENT

Development of the patented VCFS took over three years in overcoming the many challenges involved. One major challenge was how to maintain bolt load during the event of a fire. This involved addressing the sealing mechanism itself as well as the isolating washers.

Extensive testing led to the use of a hardened Inconel E-ring to perform the secondary sealing after the PTFE seal had been melted by the fire. However, the E-ring compression was quite critical, and had to be mitigated to prevent excessive compression during the burn. This led to use of the back-up ring to precisely manage E-ring compression.

Another problem was that as metallic elements, neither the E-ring nor the back-up ring provided the required isolation properties. The solution was to employ a dielectric coating that would isolate and withstand compression of the flanges.

The result was the formulation of the proprietary X37 coating which performed admirably during testing and provided isolation even after three bolt-up operations to full torque levels.

The next challenge came due to the fact that standard G-10 Glass Reinforced Epoxy (GRE) washers degraded in a fire and lost bolt load, which resulted in the release of media in a fire. This led to the development of tandem Hardened Coated Steel washers that electrically isolate, yet retain bolt load in a fire.

The combination of these elements created a system that would both electrically isolate the flanges and pass the API 6FB Fire Test.

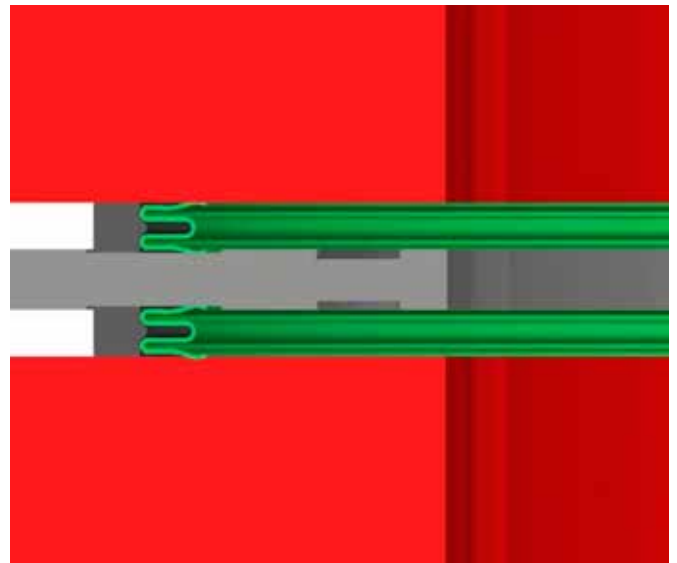

After Fire

VCS/VCFs Sealing & Isolation

API 6FB FIRE TEST

The API 6FB test requires that any sealing end connection hold for 30 minutes in a flame condition and then for a 60 minute cool down period. After the assembly is cooled to room temperature the line is de-pressurized and then re-pressurized. During all facets of the test the gasket must not exceed an API prescribed leakage rate.

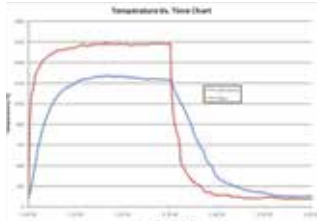

Chart 1: Temperature logging for the calorimeter blocks and thermocouples during the full 60 minute burn and cool down cycle.

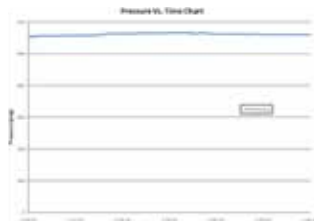

Chart 2: Pressure versus time curve for this test.

The testing assembly included 6" Class 300 VCFs kits complete with sleeves and HCS washers, 6" carbon steel flanged blinds with a 2" bore and 1" pipe welded to the outside of the flanges at the bore complete with 1" end caps. Studs and nuts for the flanges, Grade A193-B7 and 2H respectively and two high capacity propane burners, six thermocouples and six calorimeter blocks.

After the 1" pipe was welded to each of the steel flange blinds, end caps were threaded onto each pipe end. Ports were created in one of the end caps to accommodate the necessary pressure equipment. The GPT VCFs gasket was installed between the flanges and the flanged assembly was made up with a torque value of 200ft-lbs using the appropriate star pattern.

After the flange assembly was completed a Megger® isolation testing device (model MIT 481) was used to validate the gasket's isolation properties. This isolation tester was set to the highest setting of 1000V DC and the isolation between the flange-to-flange connections was measured. The isolation between the flanges and threaded stud connection was then measured using the same setting; four different isolation measurements were taken for this test at the 3, 6, 9, and 12 o'clock bolt positions.

The two large propane burners were then put into place according to API fire test protocol. These burners were ignited manually and were used to provide the flame for the thirty minute burn cycle. The flame was controlled by a valve at the central computer location; this valve was used to regulate the propane flow into the burners. Chart 1 contains the temperature logging for the calorimeter blocks and thermocouples during the full 60 minutes burn and cool down cycle.

The leakage that occurred during the 120 minute burn and cool down cycle was calculated using readings that were taken by a differential pressure transducer. Water that was used for the testing media was stored in an 8 inch pipe with an inside diameter of 8.071 (20.5cm). Using basic volume calculations, volume loss per every inch (2.54cm) of water height was determined.

System pressure was another variable that was tracked during the API 6FB test. The protocol required that pressure be held constant during the 120 minute burn and cool down cycle. Since any water leakage in the system would result in an overall pressure loss, the pressure must be increased appropriately to maintain the average pressure specified by API 6Fb testing protocol. Chart 2 shows the pressure versus time curve for this test.

For sizes below 6" on RTJ flanges and 2" on raised face flanges GPT has designed the single seal Firesafe isolating kit. The single seal utilizes the technology of the E ring to provide the seal and the Diamond-Hyde™ coating and the GRE laminate continues to give full isolation properties that are prevalent in the traditional GPT VCS design.

The VCFs is also offered in a High Temperature design that utilizes G-11 Instead of G-10. This allows the seal to service higher operating temperatures up to 392°F.

65,000psi Compressive Strength gives the seal the ability to withstand the bolting and flange stresses

750-800 VPM Dielectric Strength shows that the kit has the capacity to meet the isolation demands

0.05% Water Absorption assures that the product will not suffer from the effects of ingress from media

50,000psi Tensile Strength gives the user the confidence that the seal has the ability to withstand the internal pressures

Most of the standard bolting lubricants are conductive so GPT developed a non conductive metal free grease called Piko-Lube in order to minimize the potential of resistance loss. GPT would recommend this lubricant for use on isolating systems and it has a friction factor of 0.15.

Unlike some suppliers GPT will not offer a product that does not conform to the highest technical standards. We are proud of our achievements in design and technology and will give the support and back up necessary to provide the most suitable products. In this regard GPT is unique in the industry.

*NOTE:

The "FS" or "Fire Safe" designation denotes only that this gasket has successfully passed the API 6FB fire test. Due to the fact that every fire is unique and many uncontrolled variables are present, no other claims regarding suitability or performance in a fire are made. Each designer, user and/or operator will need to assess their individual situation when deciding to install FS style gaskets. Patent Pending.



VCS/VCFS Sealing & Isolation

COMMON VCS MATERIAL PHYSICAL PROPERTIES

ASTM	Test Method	G-10 Epoxy/ Glass	G-11 Exopy/ Glass
D149	Dielectric Strength Volts/ Mil (Short Time)	800	550
D695	Compressive Strength (psi)	65,000	50,000
D229	Water Absorption (%)	.01-.02	0.08
D257	Insulation Resistance Meg Ohms	300,000	225,000
D790	Flexural Strength (psi)	65,000	50,000
D256	IZOD Impact Strength (Ft- Lbs/Inch)	26.0	10.0
D638	Tensile Strength (psi)	51,000	41,000
D732	Shear Strength (psi)	21,000	21,000
	Temperature Range (°F)	-200 to 302	-50 to 392
	Temperature Range (°C)	-129 to 150	-46 to 200

NOTE:

G-10 for cryogenic services to -459°F / -273°C is also available.

VCS TEST RESULTS - TYPICAL

Test	VCS Value
Compression Test EN 13555 @ 150° C	140 Mpa Gasket Stress
Creep Relaxation EN 13555 @ 150° C	0.99 Relaxation Factor
Leakage Test EN 13555 @ 40 bar Helium @ 5 Mpa to 80 Mpa gasket stress	1.0 x 10 ⁻³ mg/m/s Leakage rate
Hot Blowout Test HOBT @ 151° C @ 165 bar	No Blowout
Shell Leakage Test T-2.232686 @ ambient @ 52 Mpa	4.2 x 10 ⁻⁷ pa-m ³ /s/mm Leakage Rate
Shell Cycle Test T-2.232686 @ 150° C @ 45.6 Mpa	< 0.10 bar pressure loss

ELEMENT TEMPERATURE LIMITS

	PTFE	FKM
Degrees Fahrenheit	Cryogenic to + 450	-20 to +350
Degrees Celsius	Cryogenic to +232	-29 to +177

NOTE:

Consult with a specialist for cryogenic applications and/or extreme temperature variations, hazardous fluids or for extremes in temperatures and pressures.

TORQUE TABLES

The following tables were developed to be used with GPT flange isolation gaskets including: VCS & VCFS. These tables should not be considered to contain absolute values due to the large number of uncontrollable variables involved with bolted joints. If there is doubt as to the proper value to use, we suggest that the maximum value be used.

All bolt torques values are based upon the use of new nuts (ASTM A194, GR 2H) and new bolts (ASTM A193, GR B7) of proper design, acceptable quality and approved materials of construction as well as metallurgy. It is also required that two hardened washers be used between the face of each nut and isolating washer and that a non-metallic based lubricant be used on the nuts, bolts, and washers.

VCS/VCFS Sealing & Isolation

Torque Table for VCS, VCFS (use max value for VCFS)										
NPS	150#			300#			600#			NPS
	Minimum (ft-lb)	Recommended (ft-lb)	Max (ft-lb)	Minimum (ft-lb)	Recommended (ft-lb)	Max (ft-lb)	Minimum (ft-lb)	Recommended (ft-lb)	Max (ft-lb)	
½	20	40	60	20	40	60	20	40	60	½
¾	20	40	60	40	75	120	40	75	120	¾
1	25	40	60	40	75	120	40	75	120	1
1¼	25	40	60	45	75	120	45	75	120	1¼
1½	30	40	60	80	130	210	80	130	210	1½
2	60	75	120	45	75	120	45	75	120	2
2½	65	75	120	75	130	210	75	130	210	2½
3	75	80	120	85	130	210	85	130	210	3
3½	55	75	120	85	130	210	125	205	340	3½
4	60	75	120	90	130	210	130	205	340	4
5	100	130	210	100	130	210	200	205	505	5
6	110	130	210	90	130	210	185	305	505	6
8	125	130	210	145	205	340	280	445	745	8
10	155	205	340	190	305	505	385	625	1045	10
12	170	205	340	265	445	745	400	625	1045	12
14	215	305	505	270	445	745	550	850	1415	14
16	210	305	505	380	625	1045	735	1120	1865	16
18	305	445	745	405	625	1045	970	1445	2405	18
20	295	445	745	405	625	1045	970	1445	2405	20
22	435	625	1045	705	1120	1865	1260	1825	3040	22
24	455	625	1045	775	1120	1865	1640	2265	3775	24
26	650	655	1045	685	1445	2405	2395	2400	3775	26
28	645	650	1045	870	1445	2405	2390	2775	4620	28
30	660	665	1045	905	1825	3040	3365	3370	4620	30
32	655	1120	1865	1130	2265	3775	3360	4005	6670	32
34	665	1120	1865	1445	2265	3775	3465	4005	6670	34
36	665	1120	1865	1435	2775	4620	4540	5555	9255	36
38	1015	1120	1865	1735	1740	1865	6020	6025	6670	38
40	1025	1120	1865	1785	1790	2405	5965	5970	6670	40
42	1050	1120	1865	2560	2565	2405	6125	6130	9255	42
44	1040	1120	1865	2630	2635	3040	7665	7670	9255	44
46	1050	1120	1865	2590	2595	3775	7850	7855	9255	46
48	1050	1120	1865	2660	2665	3775	10030	10035	12435	48

NOTES:

- The max recommended values is not an absolute max values for the products relevant to this table. The absolute max value for these products could exceed the maximum allowable limits of the other components in bolted flange assemblies therefore GPT has chosen not to display this information. (Please contact the factory for additional information)
- All values have been calculated assuming a 0.16 Coefficient of Friction and new nuts and bolt. If using non-lubricated bolts increase torque by 15%. If using PTFE or Xylan coated studs use Recommended values.
- "M" - Maintenance Factor = 0, "Y" - Minimum Design Seating Stress = 7500[psi] M&Y values are specific to GPT isolating gasket including: VCS, VCFS
- The above "Max" torque value is based on the use of bolts with a yield strength of 100,000[psi].
- The minimum values are based on flange design codes calling for minimum seating stress(Y value). Sometimes minimum seating stress is inadequate to seat the gasket because the bolting and flange rigidity are insufficient to effect a proper seal. Care should be taken to ensure that flange conditions provide a suitable seating surface.

VCS/VCFS Sealing & Isolation

Torque Table for VCS, VCFS (use max value for VCFS)										
NPS	900#			1500#			2500#			NPS
	Minimum (ft-lb)	Recommended (ft-lb)	Max (ft-lb)	Minimum (ft-lb)	Recommended (ft-lb)	Max (ft-lb)	Minimum (ft-lb)	Recommended (ft-lb)	Max (ft-lb)	
½	60	130	210	60	130	210	65	130	210	½
¾	65	130	210	65	130	210	70	130	210	¾
1	105	205	340	105	205	340	110	205	340	1
1¼	115	205	340	115	205	340	175	305	505	1¼
1½	170	305	505	170	305	505	250	445	745	1½
2	110	205	340	110	195	325	170	305	505	2
2½	165	305	505	170	305	505	260	445	745	2½
3	125	205	340	255	445	745	375	625	1045	3
3½	N/A	N/A	N/A	N/A	N/A	N/A	N/A	N/A	N/A	3½
4	255	445	745	385	625	1045	705	1120	1865	4
5	365	625	1045	665	1120	1865	1125	1825	3040	5
6	275	445	745	530	850	1415	1705	2775	4620	6
8	530	850	1415	935	1445	2405	1775	2775	4620	8
10	555	850	1415	1525	2265	3775	3500	5555	9255	10
12	570	850	415	1810	2775	4620	4895	7460	12435	12
14	775	1120	1865	2630	4005	6670	N/A	N/A	N/A	14
16	1025	1445	2405	3665	5555	9255	N/A	N/A	N/A	16
18	1565	2265	3775	4990	7460	12435	N/A	N/A	N/A	18
20	1945	2775	4620	6525	9760	16270	N/A	N/A	N/A	20
22	N/A	N/A	N/A	N/A	N/A	N/A	N/A	N/A	N/A	22
24	3710	5555	9255	10535	15690	26145	N/A	N/A	N/A	24
26	4865	7460	12435	N/A	N/A	N/A	N/A	N/A	N/A	26
28	6245	9760	16270	N/A	N/A	N/A	N/A	N/A	N/A	28
30	6555	9760	16270	N/A	N/A	N/A	N/A	N/A	N/A	30
32	8270	12490	20820	N/A	N/A	N/A	N/A	N/A	N/A	32
34	10255	15690	26145	N/A	N/A	N/A	N/A	N/A	N/A	34
36	10635	15690	26145	N/A	N/A	N/A	N/A	N/A	N/A	36
38	11035	15690	26145	N/A	N/A	N/A	N/A	N/A	N/A	38
40	10715	15690	26145	N/A	N/A	N/A	N/A	N/A	N/A	40
42	11085	15690	26145	N/A	N/A	N/A	N/A	N/A	N/A	42
44	13430	19390	32310	N/A	N/A	N/A	N/A	N/A	N/A	44
46	16085	23630	39380	N/A	N/A	N/A	N/A	N/A	N/A	46
48	16565	23630	39380	N/A	N/A	N/A	N/A	N/A	N/A	48

NOTES:

1. The max recommended values is not an absolute max values for the products relevant to this table. The absolute max value for these products could exceed the maximum allowable limits of the other components in bolted flange assemblies therefore GPT has chosen not to display this information. (Please contact the factory for additional information)
2. All values have been calculated assuming a 0.16 Coefficient of Friction and new nuts and bolt. If using non-lubricated bolts increase torque by 15%. If using PTFE or Xylan coated studs use Recommended values.
3. "M" - Maintenance Factor = 0, "Y" - Minimum Design Seating Stress = 7500[psi] M&Y values are specific to GPT isolating gasket including: VCS, VCFS
4. The above "Max" torque value is based on the use of bolts with a yield strength of 100,000[psi].
5. The minimum values are based on flange design codes calling for minimum seating stress(Y value). Sometimes minimum seating stress is inadequate to seat the gasket because the bolting and flange rigidity are insufficient to effect a proper seal. Care should be taken to ensure that flange conditions provide a suitable seating surface.

VCS/VCFS Sealing & Isolation

Torque Table for VCS, VCFS (use max value for VCFS)										
NPS	150#			300#			600#			NPS
	Minimum [N-m]	Recommended [N-m]	Max [N-m]	Minimum [N-m]	Recommended [N-m]	Max [N-m]	Minimum [N-m]	Recommended [N-m]	Max [N-m]	
½	27	54	81	27	54	81	27	54	81	½
¾	27	54	81	54	102	163	54	102	162	¾
1	34	54	81	54	102	163	54	102	163	1
1¼	34	54	81	61	102	162	61	102	163	1¼
1½	41	54	81	108	176	285	108	176	285	1½
2	81	102	163	61	102	163	61	102	163	2
2½	88	102	163	102	176	285	102	176	285	2½
3	102	108	163	115	176	285	115	176	285	3
3½	75	102	163	115	176	285	169	278	461	3½
4	81	102	163	122	176	285	176	278	461	4
5	136	176	285	136	176	285	271	414	685	5
6	149	176	285	122	176	285	251	414	685	6
8	169	176	285	197	278	461	380	603	1010	8
10	210	278	461	258	414	685	522	847	1417	10
12	230	278	461	359	603	1010	542	847	1417	12
14	292	414	685	366	603	1010	746	1152	1918	14
16	285	414	685	515	847	1417	997	1519	2529	16
18	414	603	1010	549	847	1417	1315	1959	3261	18
20	400	603	1010	549	847	1417	1315	1959	3261	20
22	590	847	1417	956	1519	2529	1708	2474	4122	22
24	617	847	1417	1051	1519	2529	2224	3017	5118	24
26	881	888	1417	929	1959	3261	3247	3254	5118	26
28	875	881	1417	1180	1959	3261	3240	3762	6264	28
30	895	902	1417	1227	2474	4122	4562	4569	6264	30
32	888	1519	2529	1532	3071	5118	4556	5430	9043	32
34	902	1519	2529	1959	3017	5118	4698	5430	9043	34
36	902	1519	2529	1946	3762	6264	6155	7532	12548	36
38	1376	1519	2529	2352	2359	2529	8162	8169	9043	38
40	1390	1519	2529	2420	2427	3261	8087	8094	9043	40
42	1424	1519	2529	3471	3478	3261	8304	8311	12548	42
44	1410	1519	2529	3566	3573	4122	10392	10399	12548	44
46	1424	1519	2529	3512	3518	5118	10643	10650	12548	46
48	1424	1519	2529	3606	3613	5118	13599	13606	16860	48

NOTES:

- The max recommended values is not an absolute max values for the products relevant to this table. The absolute max value for these products could exceed the maximum allowable limits of the other components in bolted flange assemblies therefore GPT has chosen not to display this information. (Please contact the factory for additional information)
- All values have been calculated assuming a 0.16 Coefficient of Friction and new nuts and bolt. If using non-lubricated bolts increase torque by 15%. If using PTFE or Xylan coated studs use Recommended values.
- "M" - Maintenance Factor = 0, "Y" - Minimum Design Seating Stress = 7500[psi] M&Y values are specific to GPT isolating gasket including: VCS, VCFS
- The above "Max" torque value is based on the use of bolts with a yield strength of 100,000[psi].
- The minimum values are based on flange design codes calling for minimum seating stress(Y value). Sometimes minimum seating stress is inadequate to seat the gasket because the bolting and flange rigidity are insufficient to effect a proper seal. Care should be taken to ensure that flange conditions provide a suitable seating surface.

VCS/VCFS Sealing & Isolation

Torque Table for VCS, VCFS (use max value for VCFS)										
NPS	900#			1500#			2500#			NPS
	Minimum [N-m]	Recommended [N-m]	Max [N-m]	Minimum [N-m]	Recommended [N-m]	Max [N-m]	Minimum [N-m]	Recommended [N-m]	Max [N-m]	
½	81	176	285	81	176	285	88	176	285	½
¾	88	176	285	81	176	285	95	176	285	¾
1	142	278	461	142	278	461	149	278	461	1
1¼	156	278	461	156	278	461	237	414	685	1¼
1½	230	414	685	230	414	685	339	603	1010	1½
2	149	278	461	149	264	441	230	414	685	2
2½	224	414	685	230	414	685	353	603	1010	2½
3	169	278	461	346	603	1010	508	847	1417	3
3½	N/A	N/A	N/A	N/A	N/A	N/A	N/A	N/A	N/A	3½
4	346	603	1010	522	847	1417	956	1519	2529	4
5	495	847	1417	902	1519	2529	1525	2474	4122	5
6	373	603	1010	719	1152	1918	2312	3762	6264	6
8	719	1152	1918	1268	1959	3261	2407	3762	6264	8
10	752	1152	1918	2068	3071	5118	4745	7532	12548	10
12	773	1152	1918	2454	3762	6264	6637	10114	16860	12
14	1051	1519	2529	3566	5430	9043	N/A	N/A	N/A	14
16	1390	1959	3261	4969	7532	12548	N/A	N/A	N/A	16
18	2122	3071	5118	6766	10114	16860	N/A	N/A	N/A	18
20	2637	3762	6264	8847	13233	22059	N/A	N/A	N/A	20
22	N/A	N/A	N/A	N/A	N/A	N/A	N/A	N/A	N/A	22
24	5030	7532	12548	14284	21273	35448	N/A	N/A	N/A	24
26	6596	10114	16860	N/A	N/A	N/A	N/A	N/A	N/A	26
28	8467	13233	22059	N/A	N/A	N/A	N/A	N/A	N/A	28
30	8887	13233	22059	N/A	N/A	N/A	N/A	N/A	N/A	30
32	11213	16934	28228	N/A	N/A	N/A	N/A	N/A	N/A	32
34	13904	21273	35448	N/A	N/A	N/A	N/A	N/A	N/A	34
36	14419	21273	35448	N/A	N/A	N/A	N/A	N/A	N/A	36
38	14961	21273	35448	N/A	N/A	N/A	N/A	N/A	N/A	38
40	14528	21273	35448	N/A	N/A	N/A	N/A	N/A	N/A	40
42	15029	21273	35448	N/A	N/A	N/A	N/A	N/A	N/A	42
44	18209	26289	43806	N/A	N/A	N/A	N/A	N/A	N/A	44
46	21808	32038	53392	N/A	N/A	N/A	N/A	N/A	N/A	46
48	22459	32038	53392	N/A	N/A	N/A	N/A	N/A	N/A	48

NOTES:

1. The max recommended values is not an absolute max values for the products relevant to this table. The absolute max value for these products could exceed the maximum allowable limits of the other components in bolted flange assemblies therefore GPT has chosen not to display this information. (Please contact the factory for additional information)
2. All values have been calculated assuming a 0.16 Coefficient of Friction and new nuts and bolt. If using non-lubricated bolts increase torque by 15%. If using PTFE or Xylan coated studs use Recommended values.
3. "M" - Maintenance Factor = 0, "Y" - Minimum Design Seating Stress = 7500[psi] M&Y values are specific to GPT isolating gasket including: VCS, VCFS
4. The above "Max" torque value is based on the use of bolts with a yield strength of 100,000[psi].
5. The minimum values are based on flange design codes calling for minimum seating stress(Y value). Sometimes minimum seating stress is inadequate to seat the gasket because the bolting and flange rigidity are insufficient to effect a proper seal. Care should be taken to ensure that flange conditions provide a suitable seating surface.

VCS/VCFS Sealing & Isolation

DOUBLE WASHER SET

Double washer set flange isolation kits include the following components for each bolt:

- Two - 1/8" thick steel washers
- Two - Isolating washers
- One - Full length isolating sleeve



SINGLE WASHER SET

Single washer set flange isolation kits include the following items for each bolt:

- One - 1/8" thick steel washer
- One - Isolating washer
- One - Isolating sleeve



G-10 ONE-PIECE SLEEVE AND WASHER SET

One-piece sleeve and washer set flange isolation kits include the following items for each bolt:

- One - 1/8" thick steel washer
- One - 1/8" thick G-10 Washer
- One - G-10 Isolating Sleeve



STEEL WASHERS

Steel washers are designed to fit over the isolating sleeve or the retainer ring on the one-piece sleeves and washers. The outside diameter is sized to fit within the bolt facing on ANSI standard flanges. They are made of 1/8" (3.2mm) thick plated hot-rolled steel. (Stainless steel available)

Full length sleeve, double washer set configuration

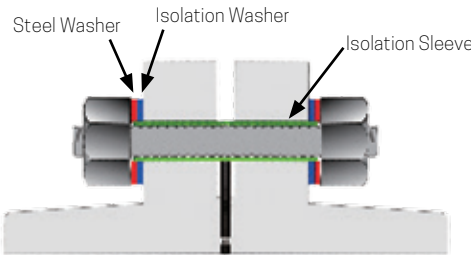

Buried Application NOTE:
Consider using the ElectroStop™ monolithic isolation fitting

APPLICATION CONSIDERATIONS

Double washer configurations may be used for added protection against the possibility of "shorting out" the nuts and bolts. In addition, double washer sets electrically isolate the nuts and bolts from both flanges.

APPLICATION CONSIDERATIONS

In buried applications, single washer configurations may be used to allow the Cathodic Protection (CP) current to reach the nuts and bolts. If desired, nuts on the opposite side of the cathodically protected flange may be included as part of the CP system.

APPLICATION CONSIDERATIONS

Easier to install, one-piece sleeves also allow the inspector a visual indication of sleeve usage.

DIAMOND-HYDE™ WASHERS

The Diamond-Hyde™ coated washer simplifies washer installation, eliminates GRE washer cracking and resists the elements better than any coated isolator washer.



1/8" WASHER MATERIAL PHYSICAL PROPERTIES

ASTM Test Method	G-10 Epoxy/Glass	G-3
D149 Dielectric Strength Volts/Mil (Short Time)	800	550
D695 Compressive Strength psi	65,000	55,000
D229 Water Absorption %	0.04	0.08
Operating Temp °F	Cryogenic to +302	Cryogenic to +392
Operating Temp °C	Cryogenic to +150	Cryogenic to +200

NOTE:

Variations in temperature or exposure to moisture will affect resistance/breakdown values.

SLEEVE MATERIAL PHYSICAL PROPERTIES

ASTM Test Method	Mylar	G-10 Epoxy/Glass	Nomex®
D149 Dielectric Strength Volts/Mil (Short Time)	400	800	550
D695 Compressive Strength psi	N/A	N/A	N/A
D229 Water Absorption %	0.8	0.04	0.08
Operating Temp °F	-75 to +300	Cryogenic to +302	Cryogenic to +392
Operating Temp °C	-59 to +149	Cryogenic to +150	Cryogenic to +200
D790 Flexural Strength psi	13,000	65,000	58,000
Cut Through Resistance ft-lbs	3,500	16,000	No Test

Nomex is a registered trademark of DuPont

VCS/VCFS Sealing & Isolation

Quantity	Nominal Pipe Size	ANSI Class	Gasket Type	Gasket Style	For VCS/VCFS		Washers	Washer Material	Sleeve	Gasket I.D. Schedule Pipe Flange	Type
Specify Below	Specify Below	150# 300# 400# 600# 900# 1500# 2500#	E = With Bolt Holes F = Ring (No Bolt Holes)	VCS VCFS	<u>Retainer</u> G-10 G-11	<u>Seal Element</u> FKM PTFE	DW = Double Washer	G-10 1.PC G-10 G-11 Nomex Diamond-Hyde™	Mylar G-10 G-11 Nomex	Specify Below	W = Weld Neck S = Slip On R = RTJ O = Other Denote Specs. & Table
Quantity	Nominal Pipe Size	ANSI Class	Gasket Type	Gasket Style	For VCS/VCFS		Washers	Washer Material	Sleeve	Gasket I.D. Schedule Pipe Flange	Type

Retainer Seal Element

FOR FLANGE ISOLATION KITS OVER 24" IN ADDITION TO THE ABOVE PLEASE SPECIFY:

Flange Facing (Raised, RTJ, etc.)	_____	Nominal Bolt Diameter (Threads/Inch)	_____
Flange I.D.	_____	Sleeve Length	_____
Flange O.D.	_____	Pipe I.D.	_____
Flange Thickness	_____	Steel Sleeve I.D. (For Concrete Pipe)	_____
Number of Studs/Bolts	_____	Product in Line	_____
Stud/Bolt Diameter	_____	AWWA Class & Table (Or other similar std.)	_____
Stud/Bolt Hole Diameter	_____	Internal Lining	_____
Stud/Bolt Circle Diameter	_____		_____

NOTE:

Caution! Bolts with smooth shank portions may not fit within sleeves. Verify prior to ordering.

WARRANTY

All products are warranted against failure caused by manufacturing defects for a period of one year. Any product found to be so defective and returned within one year from date of shipment will be replaced without charge.

The above warranty is made in lieu of, and we disclaim, any and all other warranties, expressed or implied, including the warranties of merchantability and fitness for a particular purpose, and buyer agrees to accept the products without any such warranties. We hereby disclaim any obligation or liability for consequential damages, labor costs or any other claims or liabilities of any kind whatsoever.



Flange Faces >250 Micro Inches:

For flange face surfacing greater than 250 micro inches, consult factory.



GPT WATER JET AND CNC MACHINES

GPT's water jet machinery cut intricate parts with no heat-affected zone, distortion, or mechanical stresses caused by other cutting methods. In addition, they cut with a narrow kerf, to provide better usage of raw material. As a result GPT has the ability to provide more accurate gaskets, with more intricate shapes and possibilities without wasting raw materials. CNC machines cut precise dimensions to accommodate specific seal elements and gasket tolerances.

Typical Specifications

ALL CRITICAL SERVICE APPLICATIONS

Materials for sealing gaskets on pipes containing water, aqueous fluids, oil, sour or natural gas (up to 302°F, 150°C) consist of the following components:

ISOLATION AND SEALING GASKET

One isolating and sealing gasket, VCS Type "F", 0.260" thick, 316 stainless steel core retainer laminated on both sides with a G-10 fiber glass reinforced laminate containing a precision tapered groove to accommodate the controlled compression of a PTFE spring energized seal. Sealing element placement shall accommodate either flat, raised or RTJ face flanges. The PTFE seal shall be spring and pressure energized. The G-10 retainer shall have a 800 volts/mil dielectric strength and a minimum 69,000 psi compressive strength. The I.D. of the flange isolating gasket shall matches the bore of the flange in which it is installed.

QUALITY

Isolation Kits are manufactured at a GPT facility that has a registered ISO 9001:2008 Quality Management System. Submittals shall include copy of valid registration. Performance suitability and material compatibility shall be determined by the user.

AVAILABILITY

Isolation Kits manufactured by:
GPT, Denver, CO, U.S.A.,
Telephone: 303-988-1242, Facsimile: 303-988-1922,
www.gptindustries.com e-mail: info@gpt.com

Extreme Critical Sealing for Industries

PRODUCTION FIELDS AND OFFSHORE

In gathering and injection piping, tank farms, oil and gas processing systems, and sour gas and water handling systems. Christmas trees, pumps, valves, and wherever it is important to guard against the loss of product.

PETROLEUM MARKETING FACILITIES

In terminal and tank farm piping, marine and airport fueling systems and other product handling facilities where it is essential to prevent loss of product or damage due to a flange leak or blowout.

LNG AND SNG SYSTEMS

For loading, unloading, liquefaction, regasification and processing of LNG, the production and processing of SNG, and wherever it is essential to provide a leak-proof flange for use from cryogenic to very high temperatures.

PIPELINE AND DISTRIBUTION PIPING

In compressor and pumping station piping, metering and measurement facilities, valves and other control equipment and elsewhere on a mainline piping system where a long-lasting, leak-proof flange is essential. In gas distribution piping - underground storage facilities, town border stations, industrial meter, regulator sets, and district regulators.

REFINERIES

In piping systems for heavy gasoline, caustic and acid based materials, carbon slurry, and wherever it is essential to protect plant and personnel from damage due to flange leaks or blowouts.

GPT 1:6 | 10.2016



www.gptindustries.com

4990 Iris Street
Wheat Ridge, CO 80033
Tel: (303) 988-1242
Fax: (303) 988-1922

6455 Clara Road, Suite 300
Houston, TX 77041
Tel: (713) 747-6948
Fax: (713) 747-6029

2 Woodlands Sector 1
#03-11 Woodlands Spectrum 1
Singapore 738068
Republic of Singapore
Tel:
Fax:

Unit 3-5, Chester Road
Colmworth Business Park
Eaton Socon, St. Neots
Cambridgeshire, PE 19 8YT
Tel: +44 (0) 1480 404661
Fax: +44 (0) 1480 404662

Oilfields Supply Center Ltd.
Executive Office 4, PO Box 1518
Jebel Ali Free Zone, Dubai
United Arab Emirates
Tel:
Fax: